

haque Gutenberg  
e la montagna d'Aulas



**WISE SCOOTERING**

**CATALOG 2016**

# WISE SCOOTERING IS A FREESTYLE SCOOTER

## PARTS MANUFACTURER.

The brand was created in 2011 and the team stood up at its side ever since, knowing Wise was a sponsor like no other. In 2015, we wish to get our awesome scooter parts in the hands of passionate scooter riders like us.



### What makes us different from other scooter companies?

- 100% rider owned - incredibly dedicated riders
- Each team rider is not bidding its future on full time scootering
- Each rider has a job or keeps on studying
- The ability to produce long term high quality media instead of relying on social networks only to do daily advertising among the community
- Light, strong & highly crafted scooter parts

Thanks for the support  
Balthazar NEVEU





**JULES**

**COUDERC**

Bs Lip to 180 double whip / PARIS

# Syclamp

// SINGLE CLAMP

14,95 €

PRICE

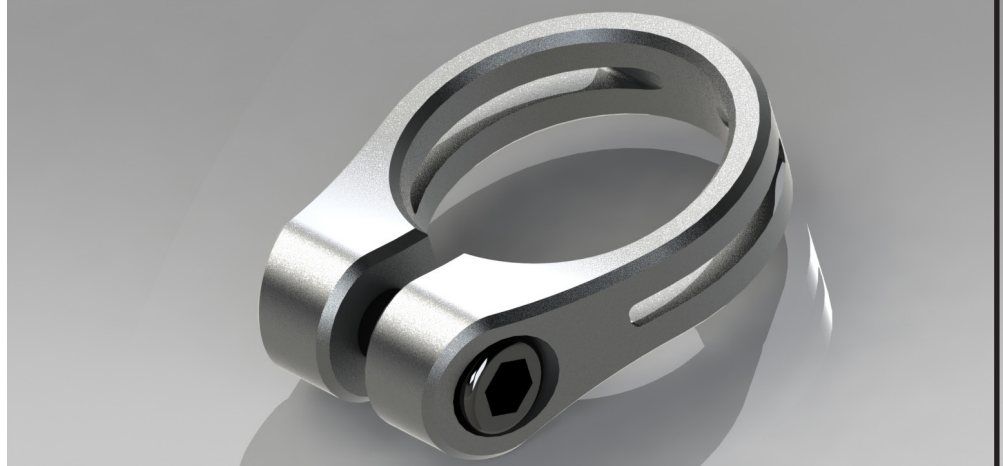
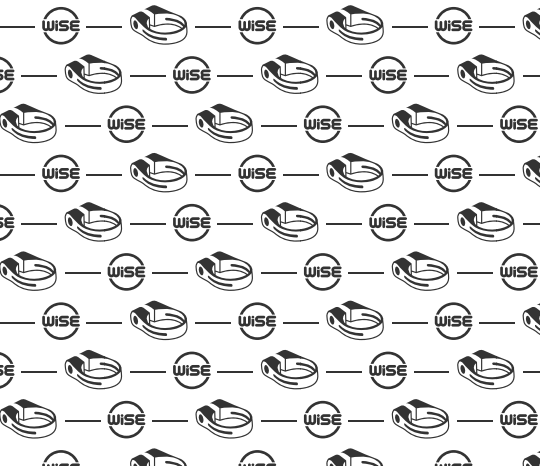

ALUMINUM

7075

AXLE

M8

COMPLIANT WEIGHT

42 gr

BARS (shim included)

31.8 / 34.9

# *diversity*

// 125 mm WHEEL

**24,95 €**

**PRICE**

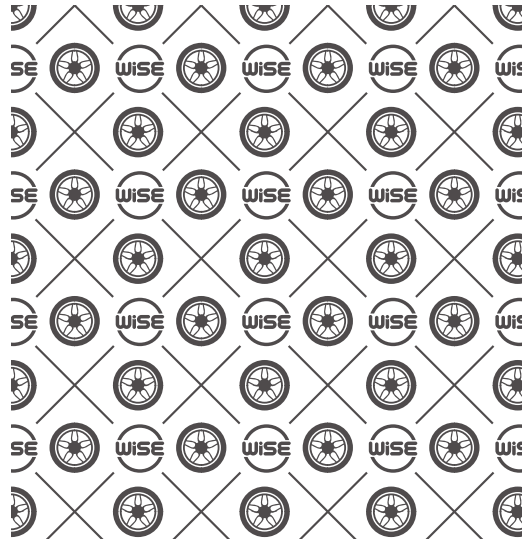

**DIAMETER**

**125 mm**

**PU**

**88A**

**WEIGHT**

**275 gr**



Vans  
Official Sponsor

**ALEXIS**

**CUVILLIER**

Fs Wall ride / BARCELONA

# flexpegs

// DOUBLE PEGS

29,95 € PRICE

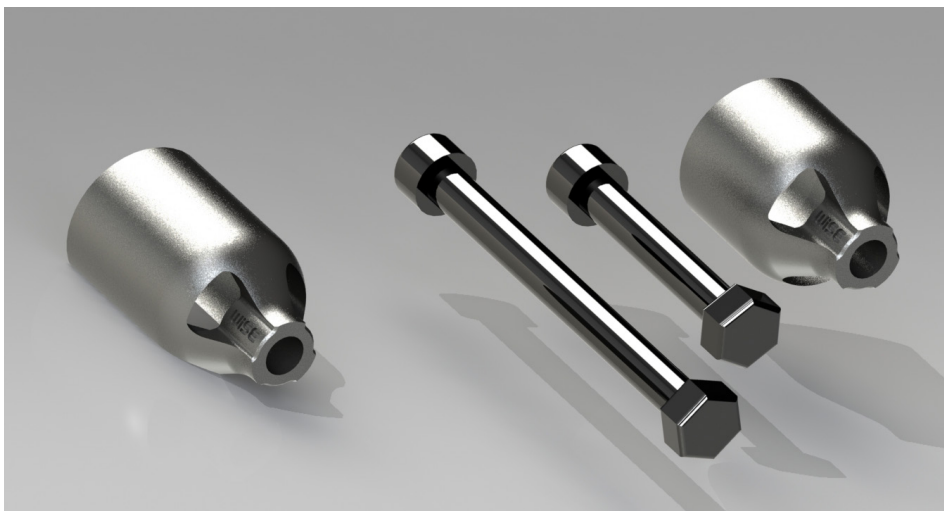
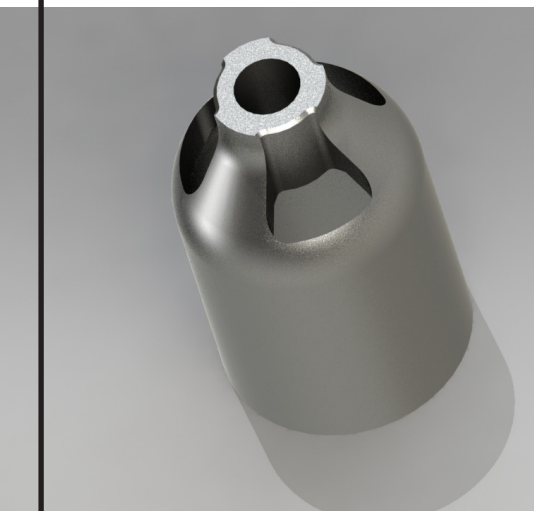
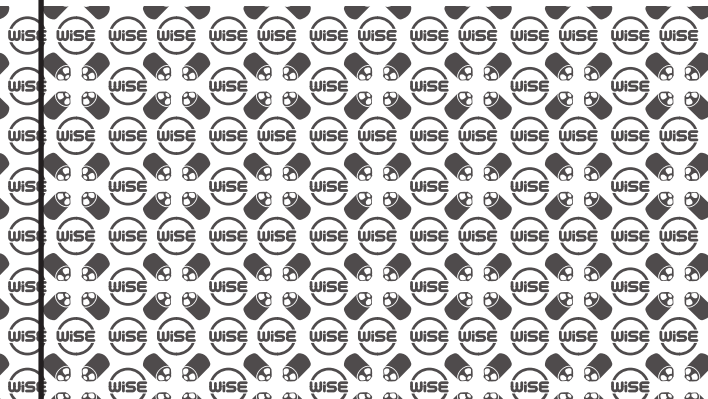

DIAMETER **30 mm**

LENGTH **40 / 50 mm**

WEIGHT **183 gr**

ALU **6061**

AXLES (included) **M8**

**ANTOINE**

**DELCAMPE**



**BALTHAZAR**

**NEVEU**



Area pour enfants  
de 2 à 12 ans.  
Présence de matériel  
pour les enfants de moins de 3 ans.  
Attention aux objets en hauteur.

# duality

// DOUBLE CLAMP

**29,95 €** PRICE

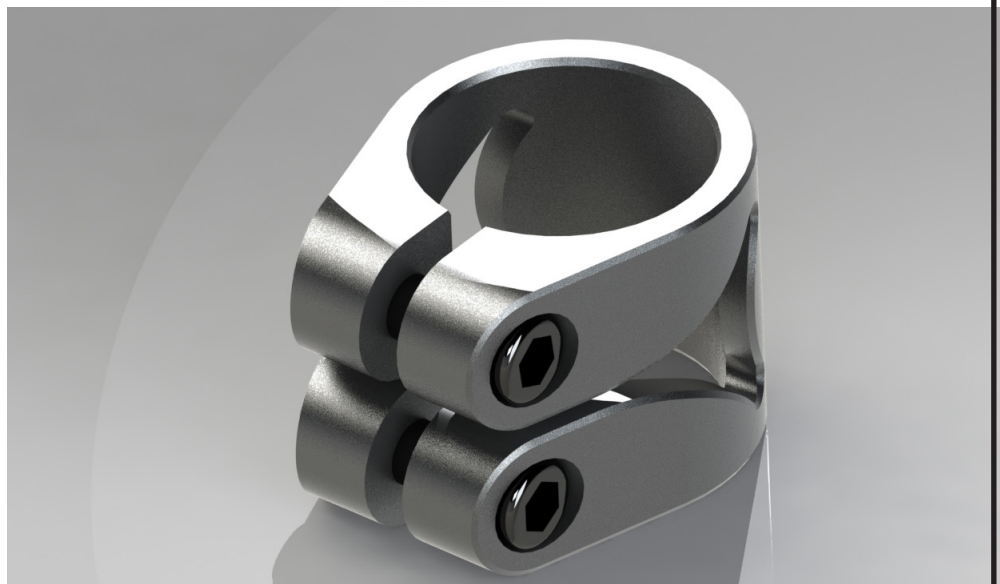
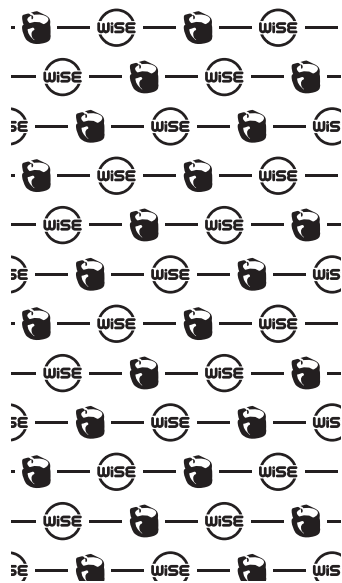
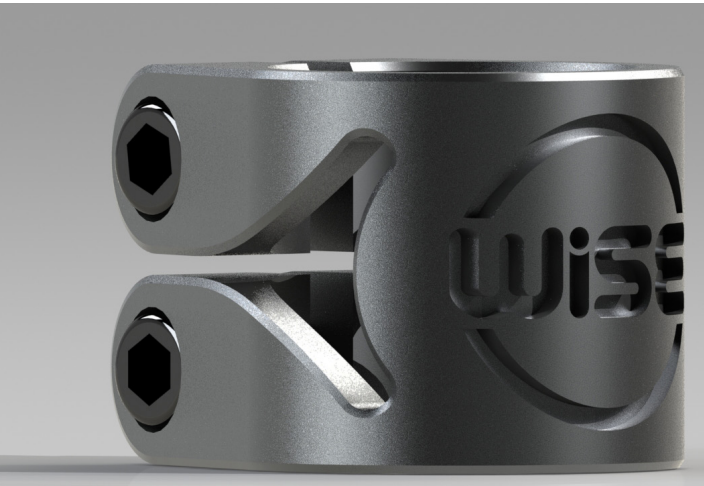

ALUMINUM

**7075**

AXLE

**M8**

COMPLIANT WEIGHT

**78 gr**

BARS (shim included)

**31.8 / 34.9**

# forkrast

// FORK

**74,95 €** PRICE

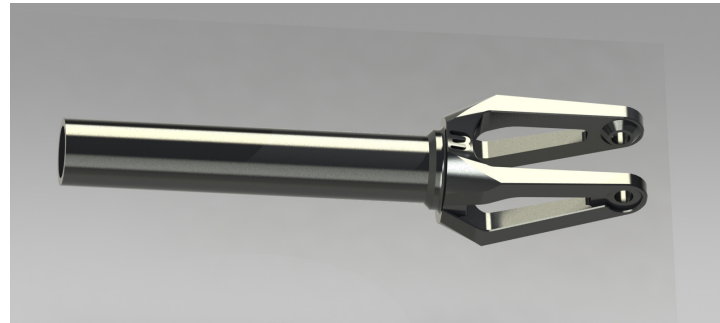
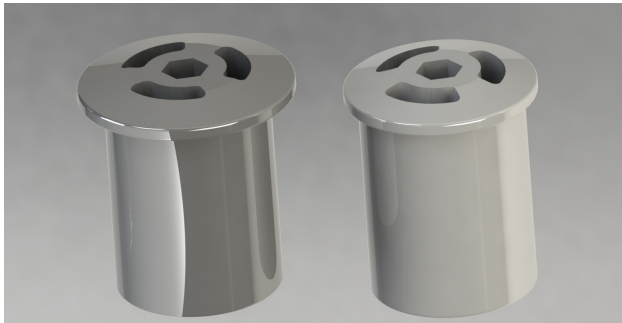
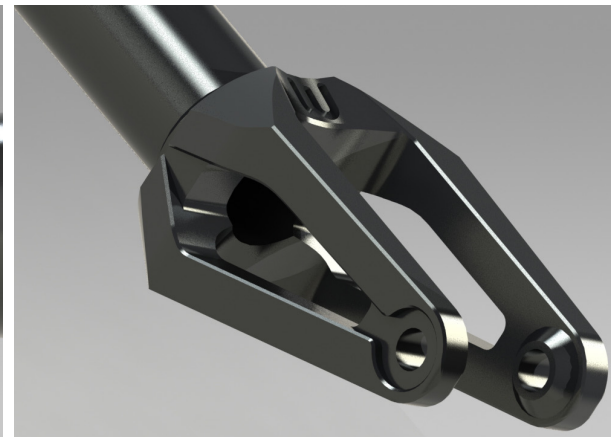
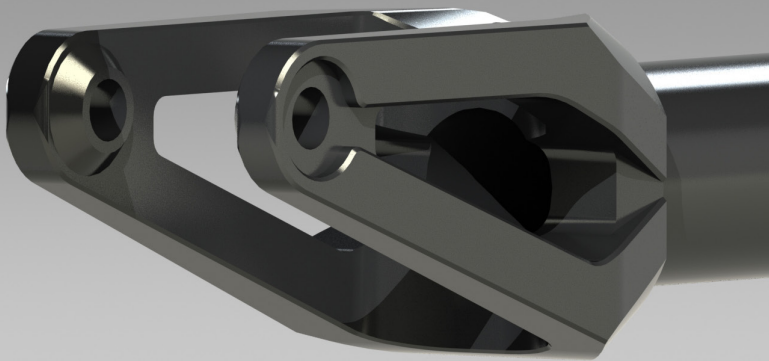
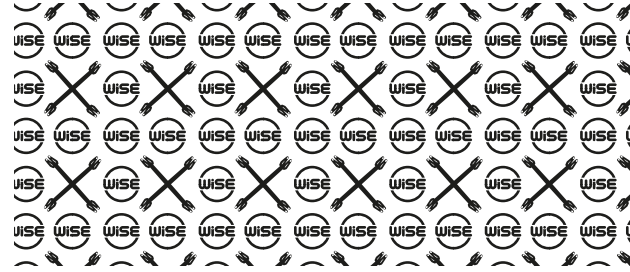

**ALU** **7075**

**WHEELS** **125 mm**

**WEIGHT** **293 gr**

**AXLE** **M8**

**TOP CAPS INCLUDED FOR** **SCS** **HIC** **ICS**

MARTIN

ANDRE



# Tundred

// 110 mm WHEEL

29,95 €

PRICE

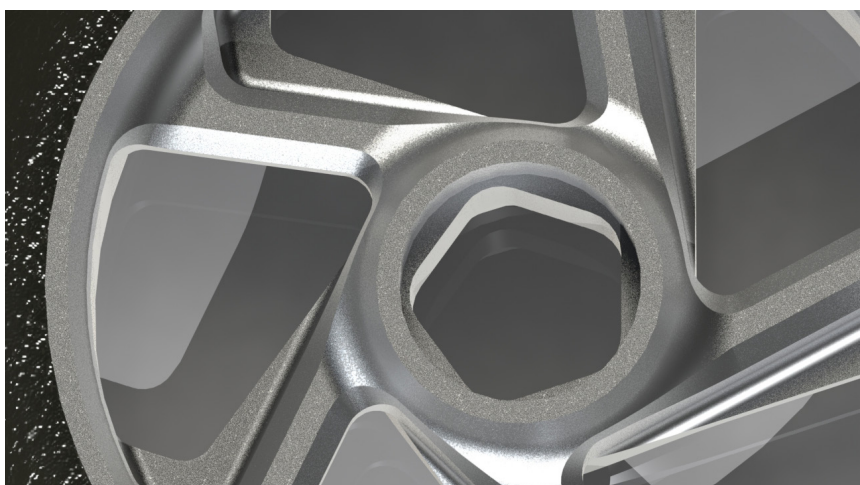
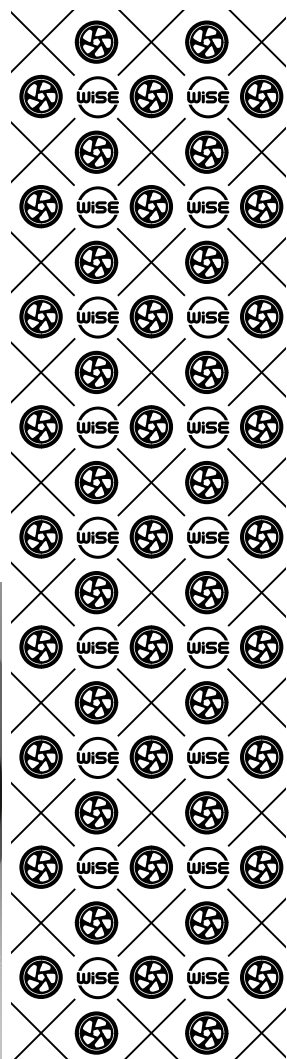

DIAMETER

110 mm

PU

88A

WEIGHT

203 gr



**REMI**

**BOUCHARD**





## SYCLAMP

7075-ALUMINIUM  
M8-AXLE COMPLIANT WITH 34.9 BARS

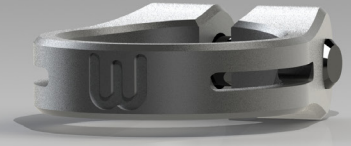
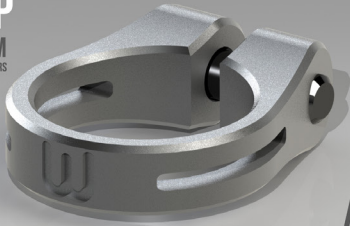

14,95€

## DUALITY

7075-ALUMINIUM  
M8-AXLE COMPLIANT WITH 34.9 BARS

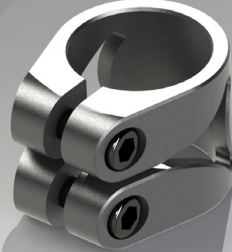

29,95€

## TUNDRED

110MM - 88A PU

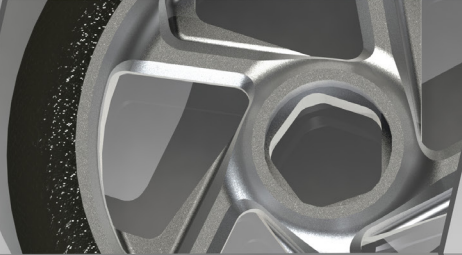

29,95€

## FORKAST

7075-ALUMINIUM  
COMPLIANT WITH 125MM WHEELS  
SCS & HIC/ICS CAPS INCLUDED  
M8-AXLE

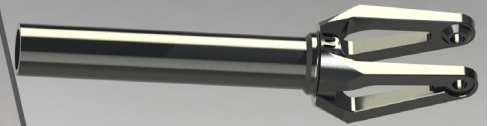

74,95€

## FLEKPEG

4130-CR STEEL  
M8-AXLE INCLUDED

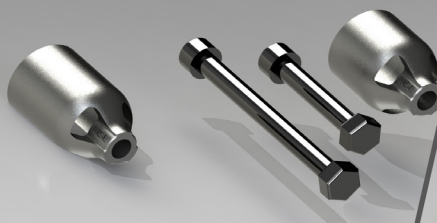

29,95€

## FIVERSITY

125MM - 88A PU



24,95€

[www.wisescootering.com](http://www.wisescootering.com)

—  
Wise Scootering Limited  
Unit E m/f Tower B, Billion Ctr. 1 Wang Kwong Rd.  
Kowloon Bay  
Hong Kong

—  
[wisescootering@gmail.com](mailto:wisescootering@gmail.com)